

Closed Box Staircase

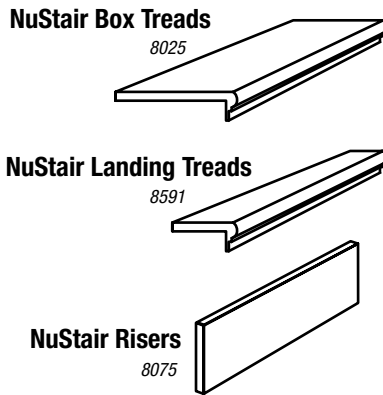

- 1 Identify your staircase**
 -Closed, open, or combination
 -Identify your starting steps
- 2 Count and measure**
 -Count number of stair treads and risers
 -Measure the width of the stair treads and risers
- 3 Complete the Project Order Form**
 -easy way to detail your materials list

Staircase Starting Steps

Staircases can begin with open end treads, starting steps, or combinations of both. To determine whether a stair tread is left or right facing, stand at the bottom of the stairs and look up the staircase.

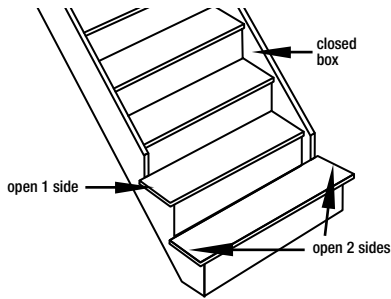

Open Side(s)

Any treads open on 1 side or open 2 sides

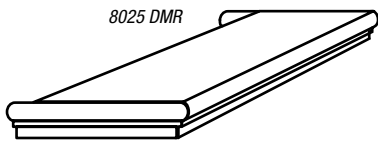

NuStair Double Miter Return Treads

- scotia molding on front and both sides
- use for all open stair applications
- trim one end off for open 1 side

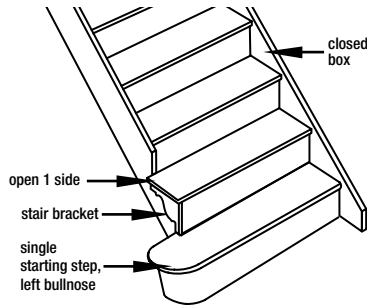

Single Starting Step

1 side bull nose

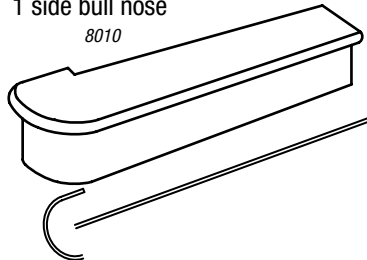

NuStair Single Bullnose Tread

- one side has round bullnose
- can be used with right or left bullnose
- comes with riser and universal molding trim kit

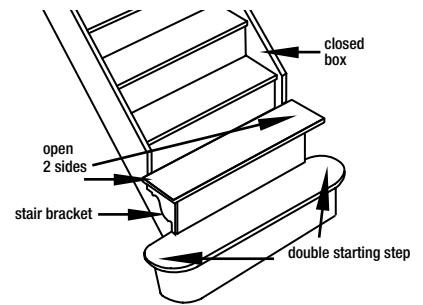

Double Starting Step

2 sides bull nose

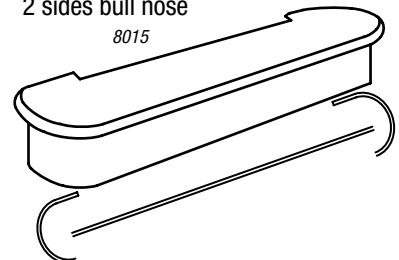

NuStair Double Bullnose Tread

- both sides have round bullnose
- comes with riser and universal molding trim kit



NUSTAIR®
STAIR REFACING SYSTEM
 by IDEAL STAIR PARTS
www.NuStair.com

For more information, visit our website at www.NuStair.com
 Our website contains comprehensive information on our full line of products, FAQ's, and videos.

Scan this QR code with your smart phone to watch a video on NuStair.

Customer Name: _____ Store #: _____
 Address: _____ Phone: _____
 City, State: _____ Location: _____
 Measured by: _____ Date: _____ PO#: _____

5/8" NuStair Box Tread
8025

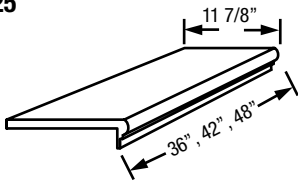

- Species:
 Red Oak
 Brazilian Cherry
- Finish:
 Unfinished Natural
 Butterscotch Gunstock

36" qty. _____ 42" qty. _____ 48" qty. _____

5/8" NuStair Landing Tread

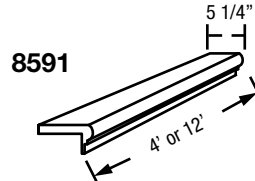

- Species:
 Red Oak
 Brazilian Cherry
- Finish:
 Unfinished Natural
 Butterscotch Gunstock

4' qty. _____ 12' qty. _____

3/4" NuStair Riser
8075

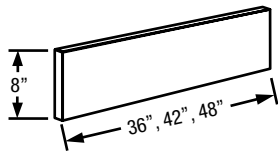

36" qty. _____ 42" qty. _____ 48" qty. _____

note: standard staircases have 1 more riser than treads

- Species: Red Oak Brazilian Cherry Primed
 Finish: Unfinished Natural Butterscotch Gunstock

5/8" NuStair Double Miter Return Tread 8025DMR

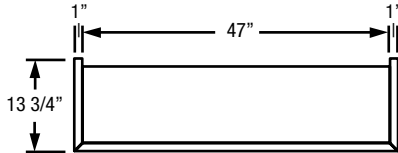

48" qty. _____

- Species: Red Oak Brazilian Cherry Primed
 Finish: Unfinished Natural Butterscotch Gunstock

NuStair Single Starting Step 8010

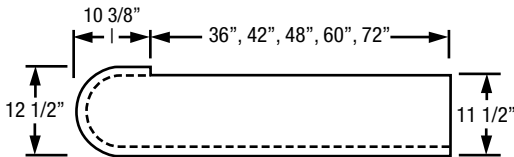

Left Right
 36" qty. _____ 42" qty. _____ 48" qty. _____ 60" qty. _____ 72" qty. _____

- Species: Red Oak Brazilian Cherry
 Tread Finish: Unfinished Natural Butterscotch Gunstock
 Riser Finish: Primed Matching Tread

NuStair Double Starting Step 8015

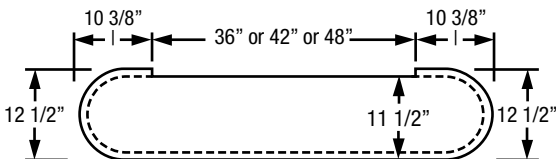

36" qty. _____ 42" qty. _____ 48" qty. _____

- Species: Red Oak Brazilian Cherry
 Tread Finish: Unfinished Natural Butterscotch Gunstock
 Riser Finish: Primed Matching Tread

Stair Bracket
8028

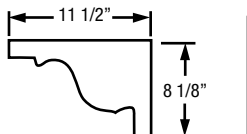

qty. _____

Mold & Scotia
8585

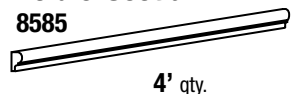

4' qty. _____



NuScribe

qty. _____